



## **Manual de Montagem Curral Brinquedo**



**Manual de Montagem**  
**Curral Brinquedo**

**Passo 01**

Separe a base

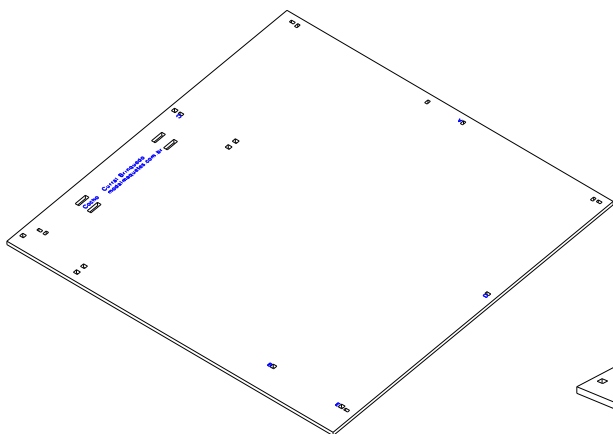

**Passo 2A**

Separe as peças do cocho.

Use cola para madeira, permitirá o alinhamento no momento da colagem.

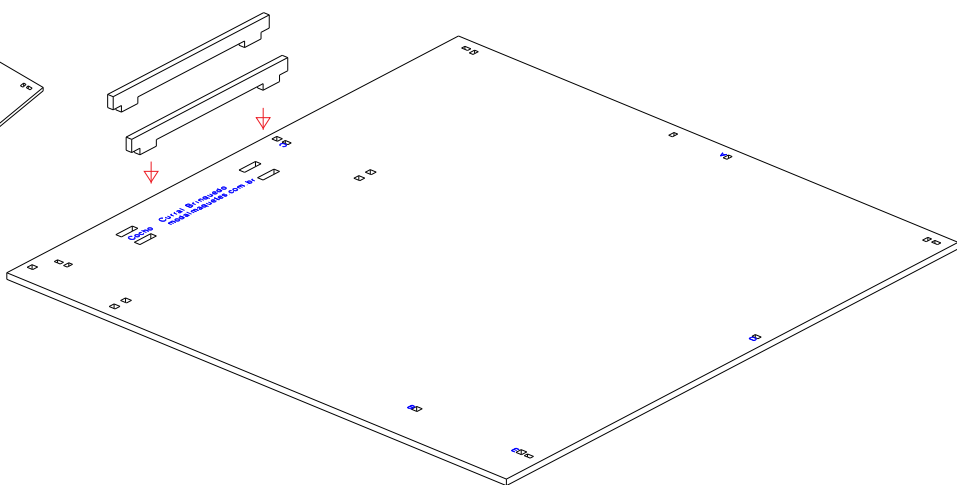

**Passo 2B**

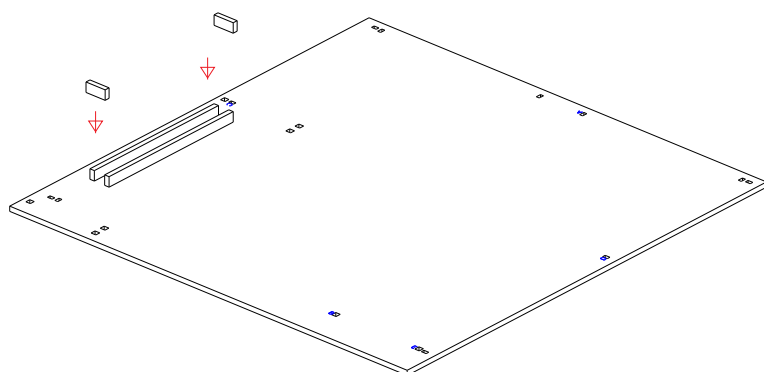

**Passo 2C**

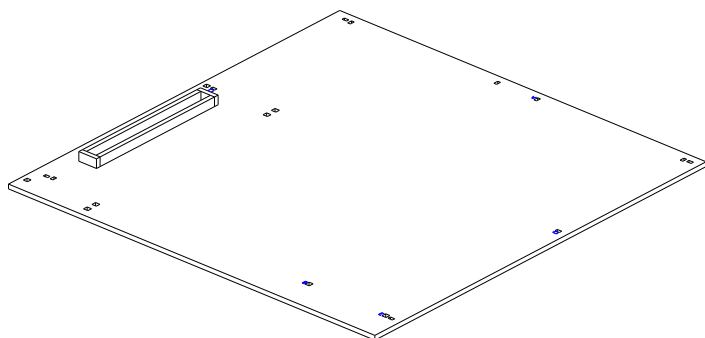



**Manual de Montagem**  
**Curral Brinquedo**

**Passo 3A**

Separe a cerca identificada com a letra A.

Passa cola em toda parte inferior da peça, onde terá contato com a base. São 10 pontos de contato.

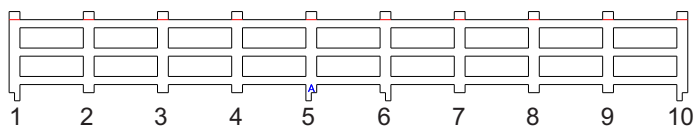

**Passo 3B**

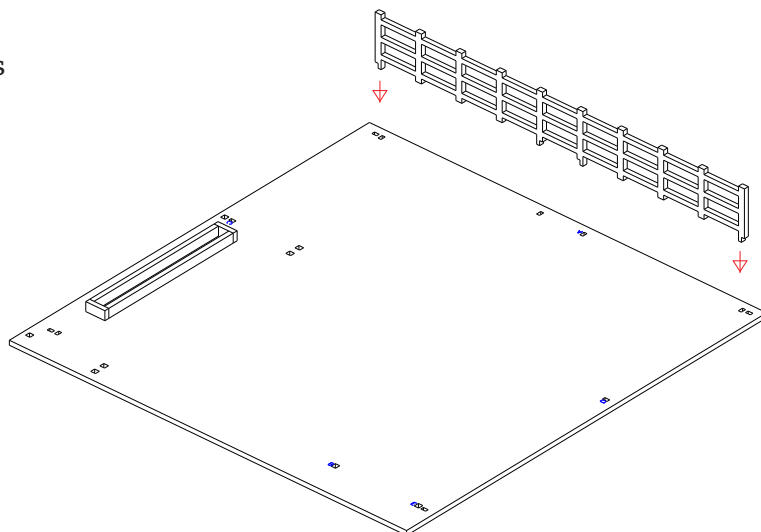

**Passo 3C**

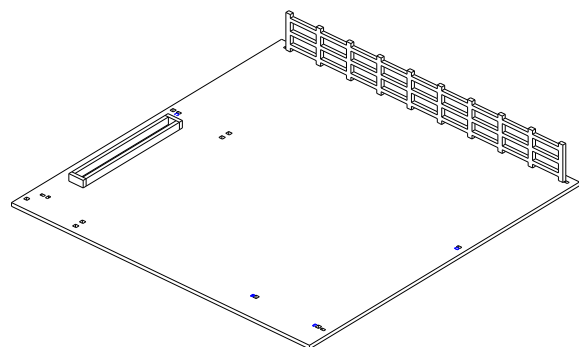

**Passo 4A**

Separe a cerca B

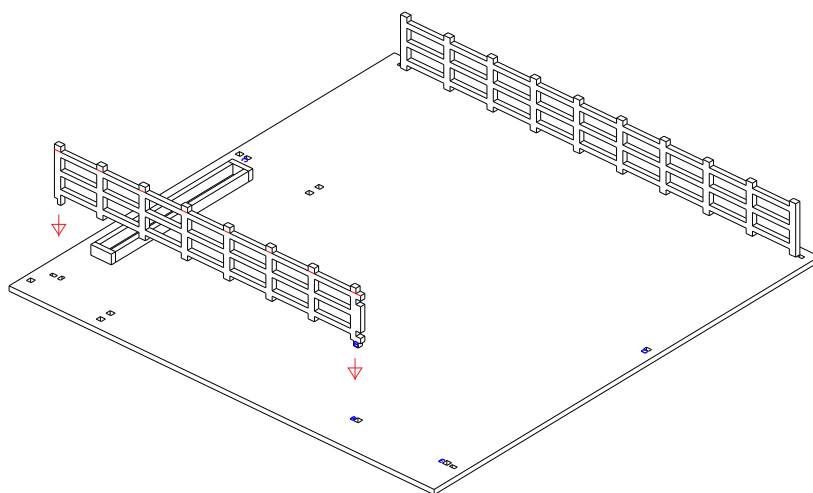



**Manual de Montagem  
Curral Brinquedo**

Passo 4B

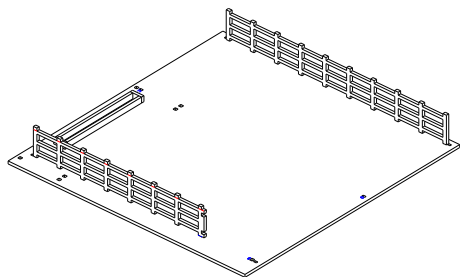

Passo 5A  
Separe a cerca C

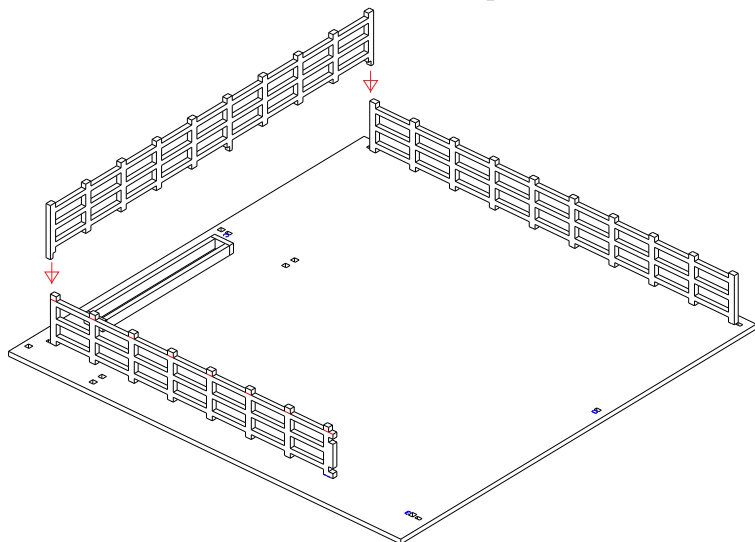

Passo 5B

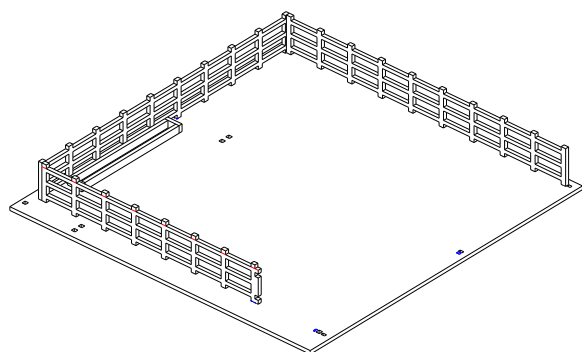

Passo 6A  
Separe a cerca D

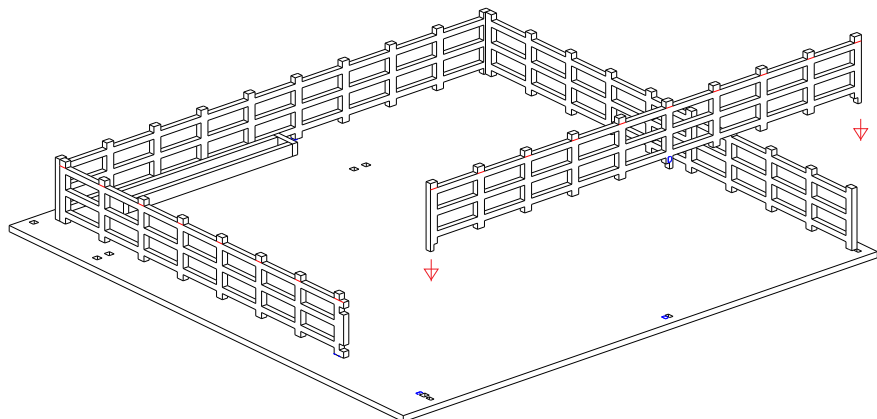



**Manual de Montagem  
Curral Brinquedo**

Passo 6B

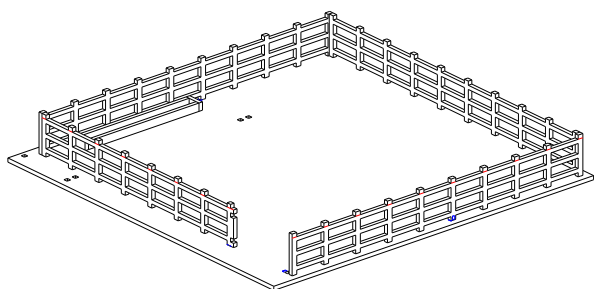

Passo 7A

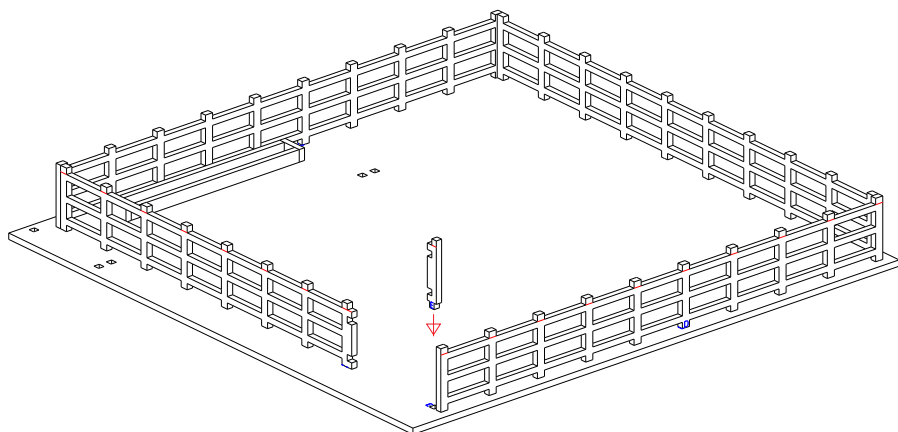

Passo 7B

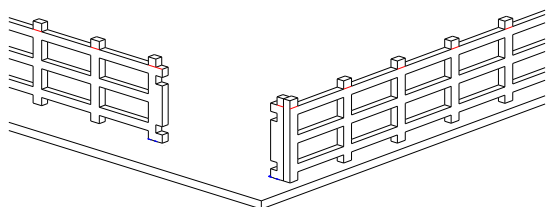

Passo 8A

Estrutura do Telhado

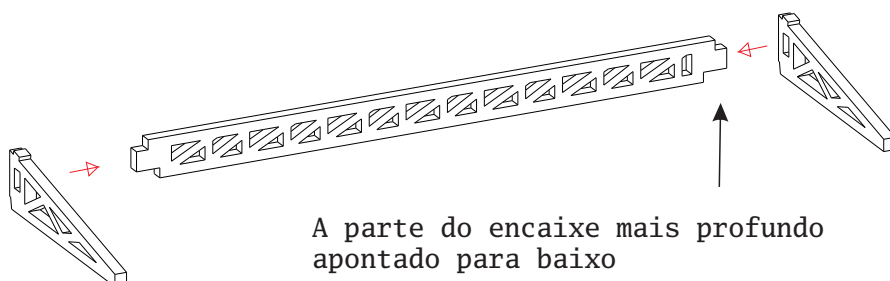



Manual de Montagem  
Curral Brinquedo

Passo 8B

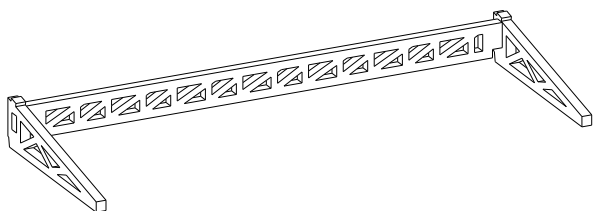

Passo 8C

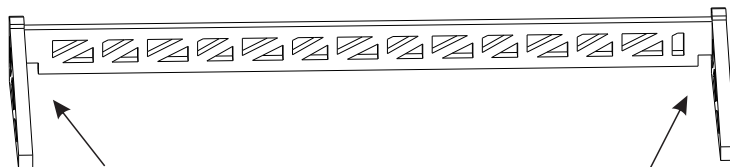

Encaixe livre para os pilares

Passo 9A

Separar o maior pilar  
com 5,7 cm de altura

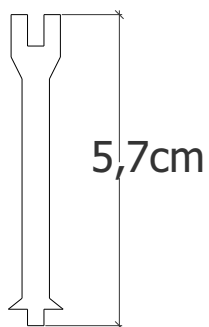

Passo 9A

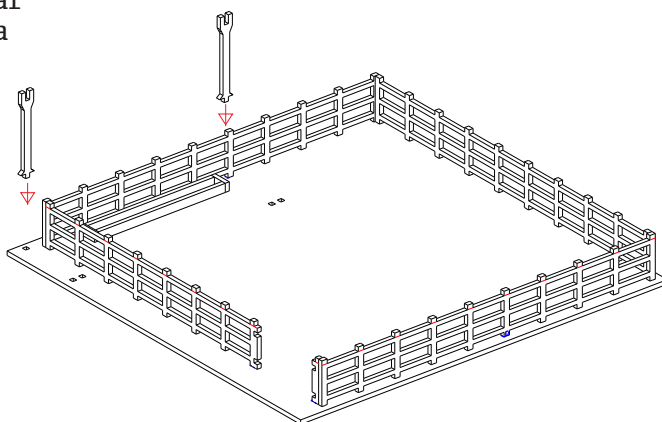

Passo 9C

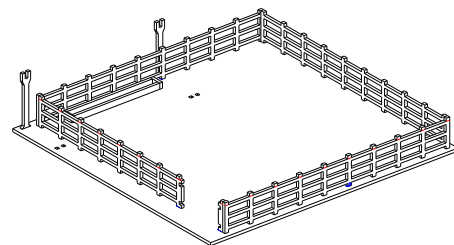



Manual de Montagem  
Curral Brinquedo

Passo 10A

Pilares Menores

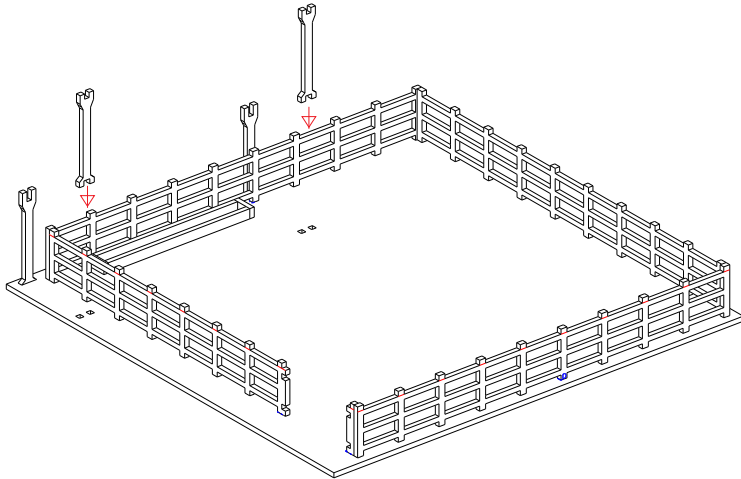

Passo 10B

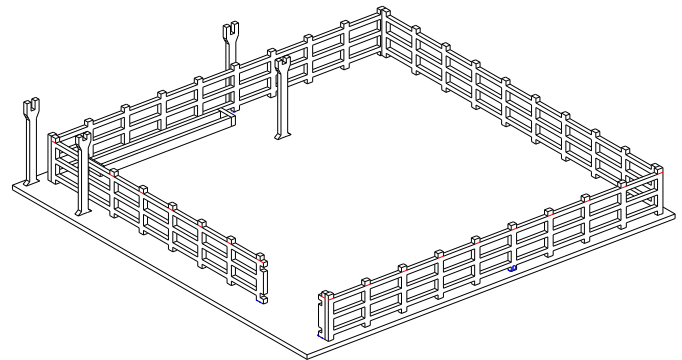

Passo 10C

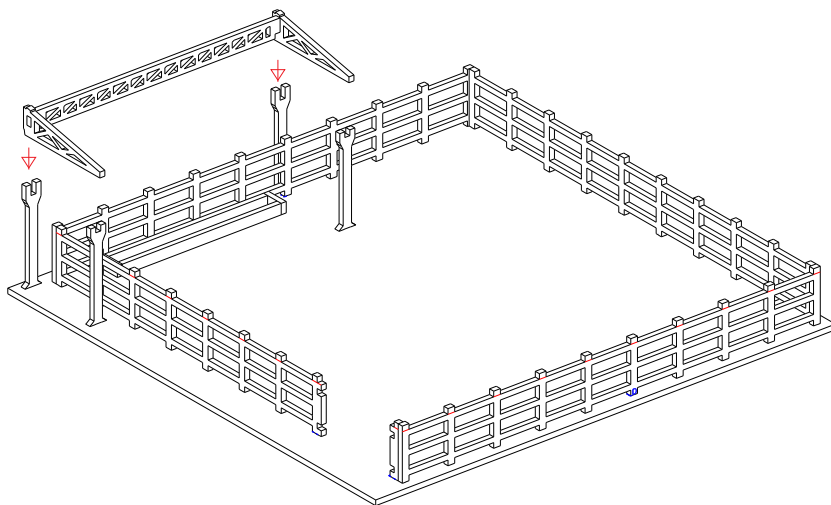

Passo 10D

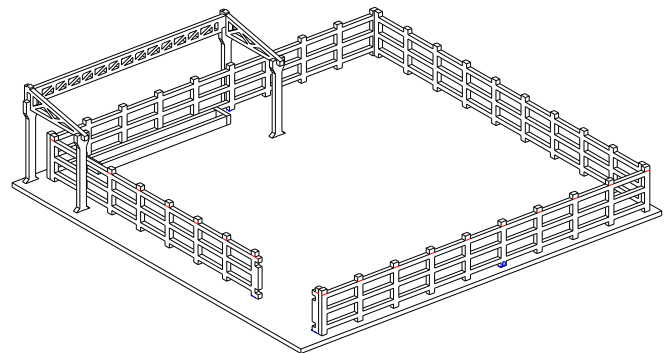



## Manual de Montagem Curral Brinquedo

### Passo 11A

Separar a base de papel Rígido com as suas respectivas cercas

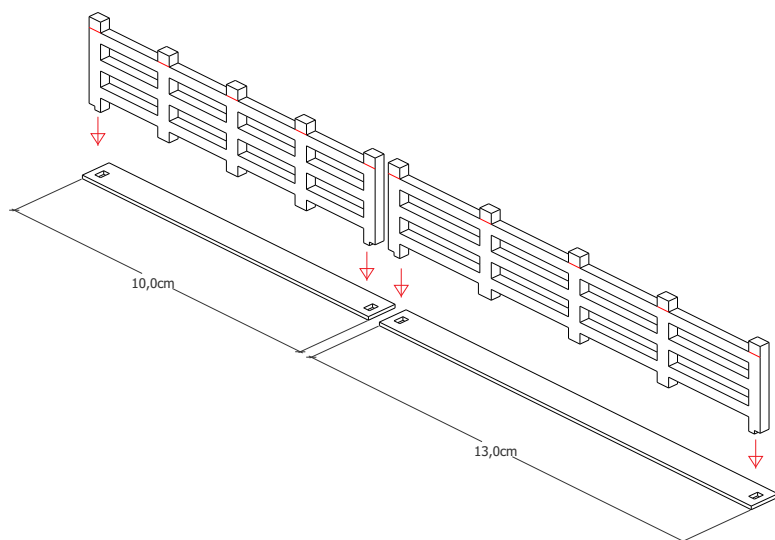

### Passo 11B

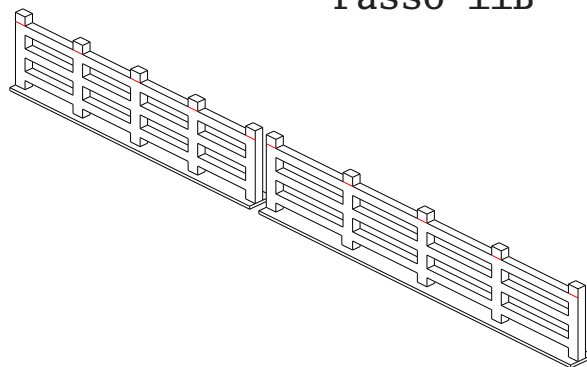

### Passo 11C

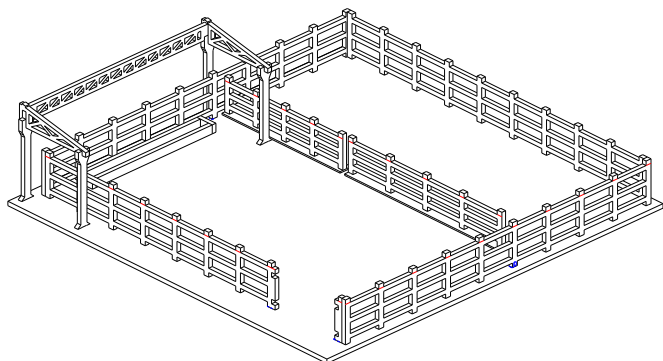

### Passo 12A

Os portões não precisam ser colados

Se desejar cole uma fita crepe nos portões, que servira como dobradiça.

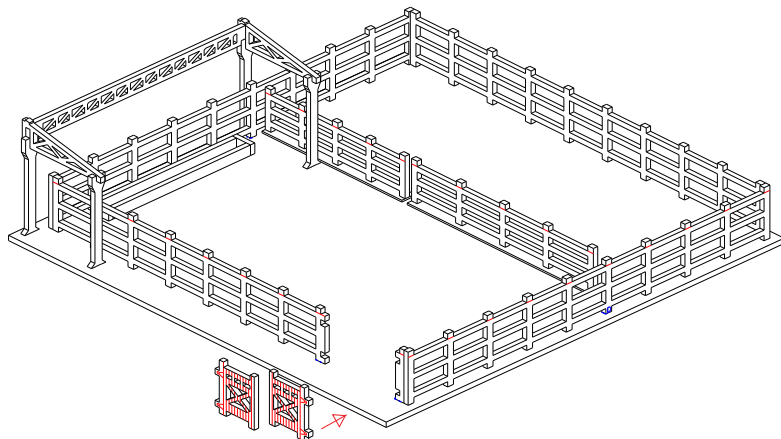





Passo 12B

